







Model Code: 13 CAN280EG

Included Accessories

 ICM12	 13 WKROF9040NEG	 14 WK-ODN-EG
 Drainer Grid	 Sink Care Pack	

Optional Accessories

 UMG8	 14 CBF260R10N	 14 CBF340R10N
 13 DTN18EG		

Dimensions

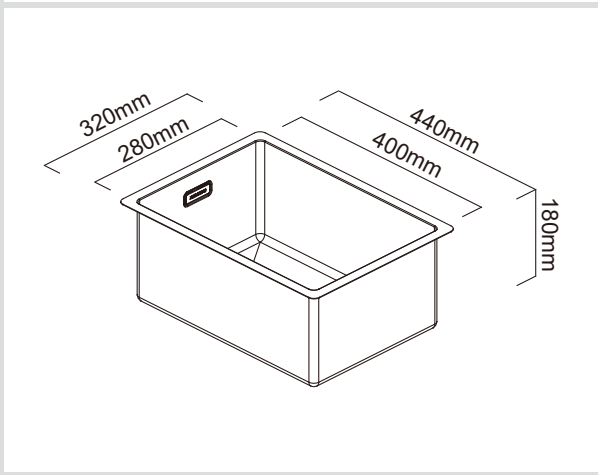

Specifications

Description	Single Bowl, Undermount/Inset Sink
Overall Sink Size	320mm x 440mm x 180mm deep
Bowl Dimensions	280mm x 400mm x 180mm deep
Drainer Length	N/A
Technic	Fabrication
Material	Stainless steel SUS304

Installation

Fixings	Inset clips supplied
Template	N/A
Min Cabinet Size	400mm
Waste Holes	1 x 90mm round Compatible with waste disposal

Plumbing

Waste Fittings	1 x (90mm x 1 1/2") basket wastes included
Overflow	Included

Packaging

Carton Type	EPS protection & individual carton
Gross Weight	4.55Kg
Carton Size	400mm x 286mm x 513mm
Pack QTY	1

SURFACE FINISH



WASTE KIT

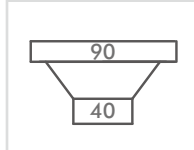

MATERIAL



INSTALLATION OPTIONS

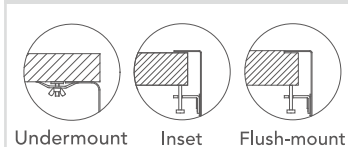

PROFILE



Burns & Ferrall is pleased to offer a limited 25-year warranty on all Zomodo sinks used in normal domestic installations. Burns & Ferrall warrants its sinks to be free from all manufacturing defects in material and workmanship. Burns & Ferrall warrants Zomodo waste kits, basket sieves and overflow assembly to be free from manufacturing defects for a period of one (1) year. Burns & Ferrall warrants Zomodo taps' stainless steel casing to be free from manufacturing defects for a period of twenty-five (25) years, the supply hose and inner cartridge for a period of five (5) years, and the inner parts including the aerator and O-ring for a period of one (1) year from the date of purchase. Burns & Ferrall will repair or replace (at Burns & Ferrall's discretion), at no charge, excluding labour, any product supplied by Burns & Ferrall that is proven to be defective under normal use.

Please visit www.zomodo.co.nz/warranty for full terms & conditions.