

STAMPED LOGO DETAILS

A
5:1

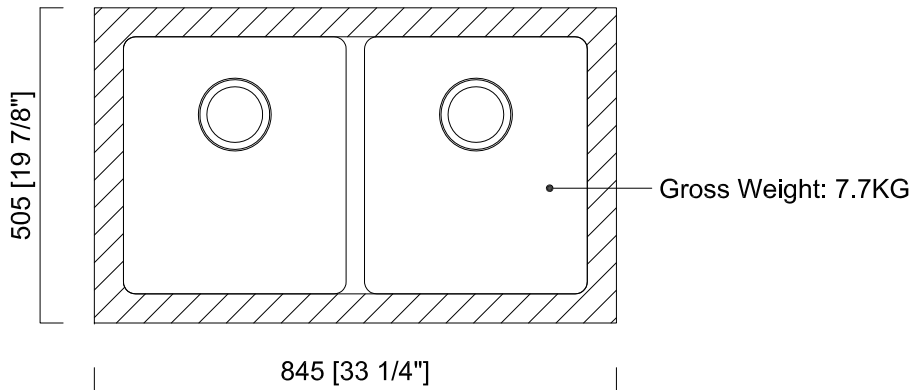

PACKAGING DIAGRAM

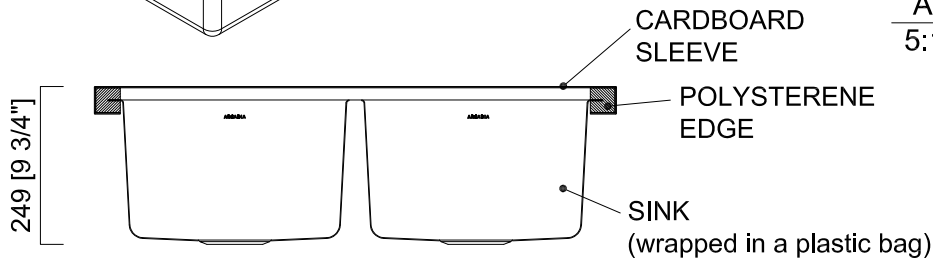
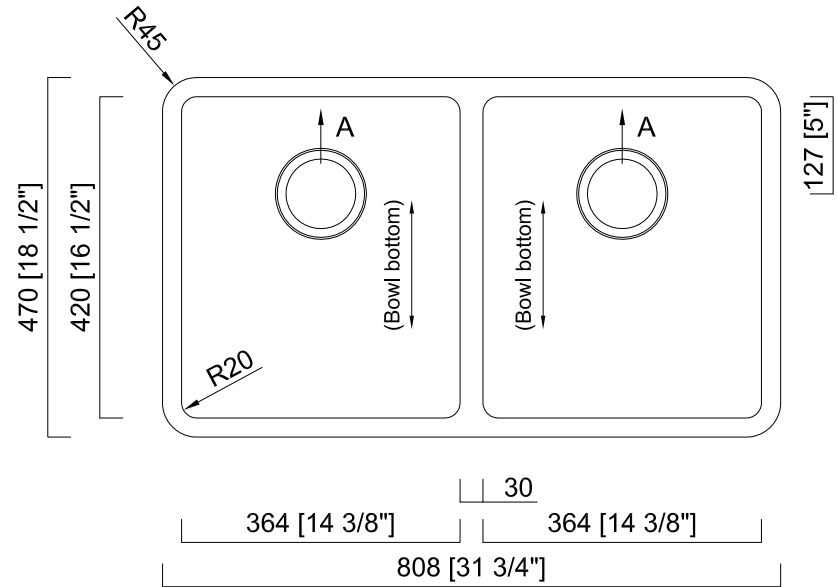
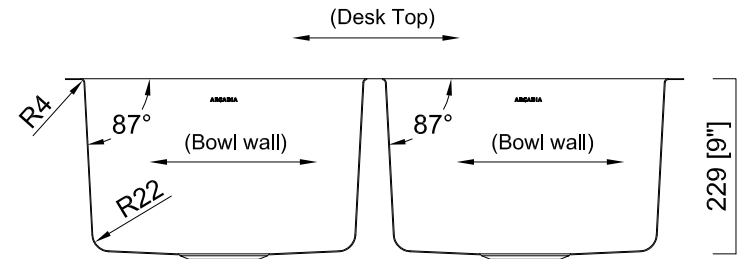

1. Undercoating (dark grey), sound pad on the bottom.
2. Waste kit, drainage tail pipe and clip set packed in box on pallet.
3. Packaging Option: Nested Pallet (50+ sinks)
5-Pack (20+ sinks)

ARCADIA

Product code	ARC200U
Material	SUS304 - 16ga
Finish	Brush
Date	7 Nov 2023